

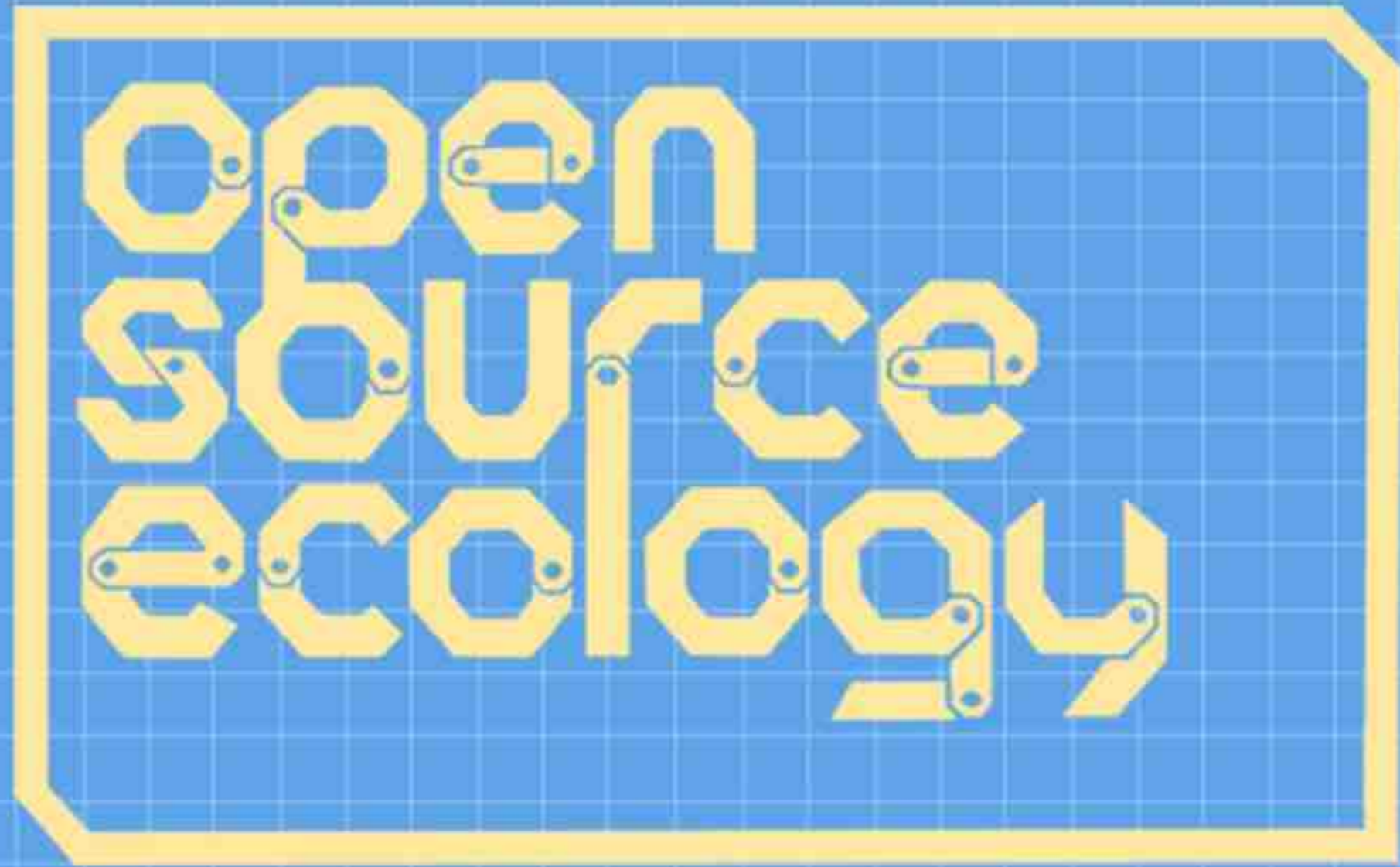

Hi,

I'm Marcin





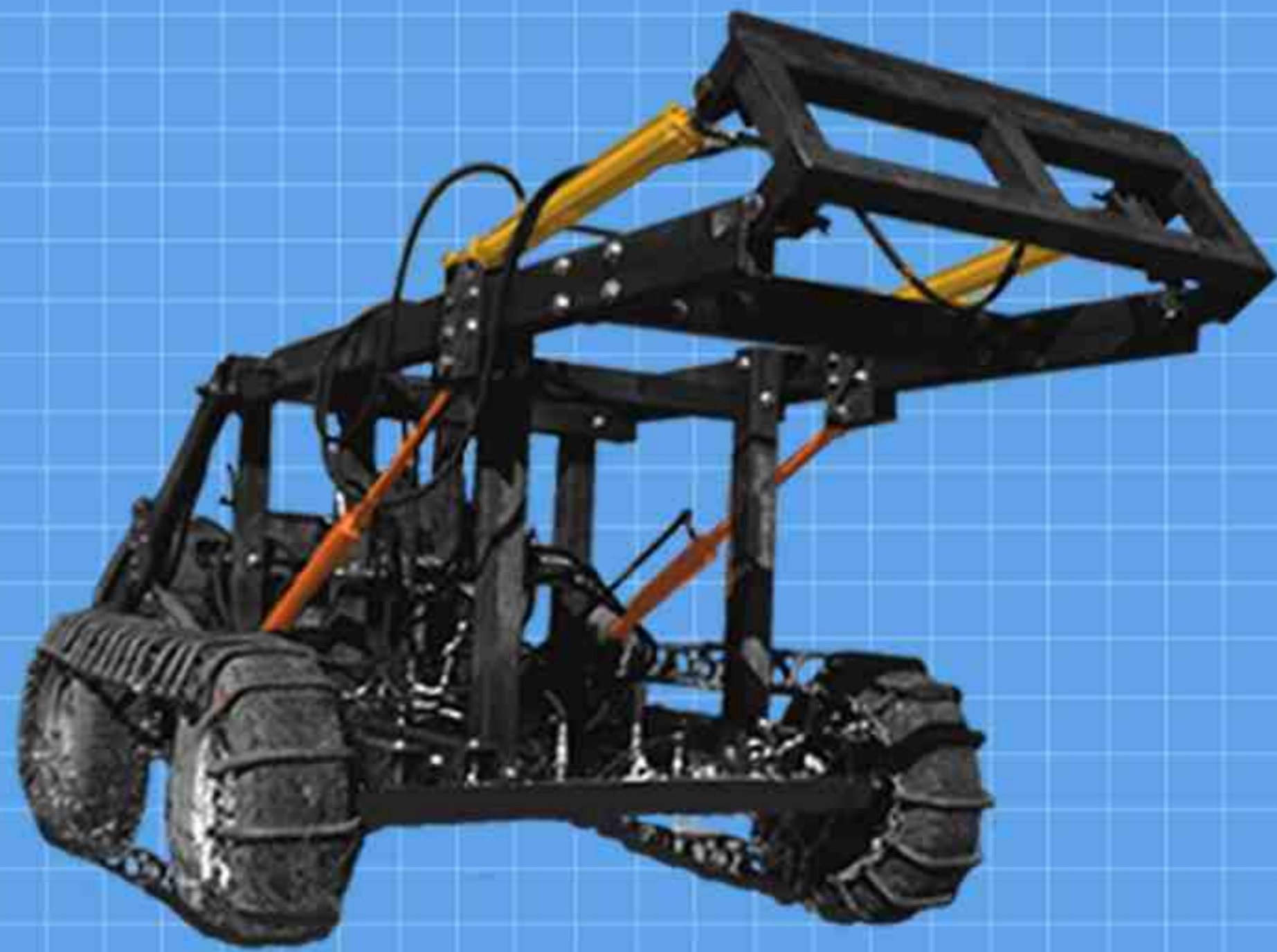





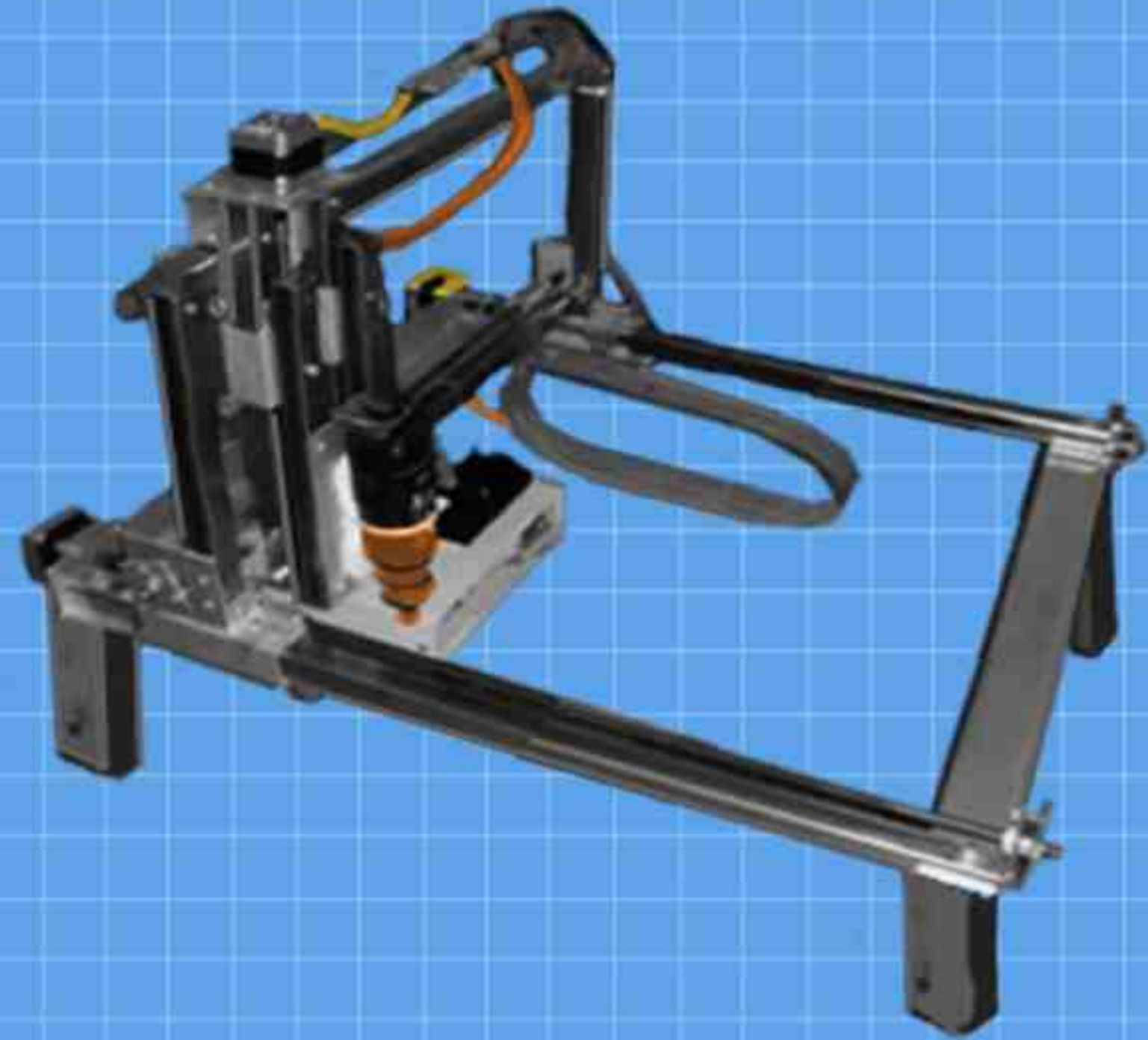





# Global Village Construction Set







Handwritten physics notes covering various topics including:

- Angular Momentum:**  $L = r \times p$ ,  $L_z = mvr \sin\theta \cos\phi$ ,  $L^2 = \hbar^2 l(l+1)$ ,  $L_x = \frac{\hbar}{2} \sigma_x$ ,  $L_y = \frac{\hbar}{2} \sigma_y$ ,  $L_z = \frac{\hbar}{2} \sigma_z$ .
- Quantum Mechanics:**  $\psi(r, \theta, \phi) = R_{nl}(r) Y_{lm}(\theta, \phi)$ ,  $E_n = -\frac{13.6 \text{ eV}}{n^2}$ ,  $\Delta \psi + V\psi = E\psi$ ,  $\Delta \psi = -\frac{2m}{\hbar^2}(E - V)\psi$ .
- Hydrogen Atom:**  $r_{Bohr} = 5.29 \times 10^{-11} \text{ m}$ ,  $v = \frac{e\hbar}{2m_0 a_0} \approx 2.2 \times 10^6 \text{ m/s}$ ,  $\lambda = \frac{h}{p}$ .
- Probability:**  $N(\theta) = \frac{dN}{d\Omega} = \frac{1}{4\pi} \frac{dN}{d\Omega}$ ,  $\int |\psi|^2 dV = 1$ .
- Relativity:**  $E = mc^2$ ,  $E^2 = p^2 c^2 + m_0^2 c^4$ ,  $E = \gamma mc^2$ ,  $p = \gamma m_0 v$ .
- Diagrams:** Spherical coordinate systems, probability distributions, and energy level diagrams.





**Out of sight, out of mind.**































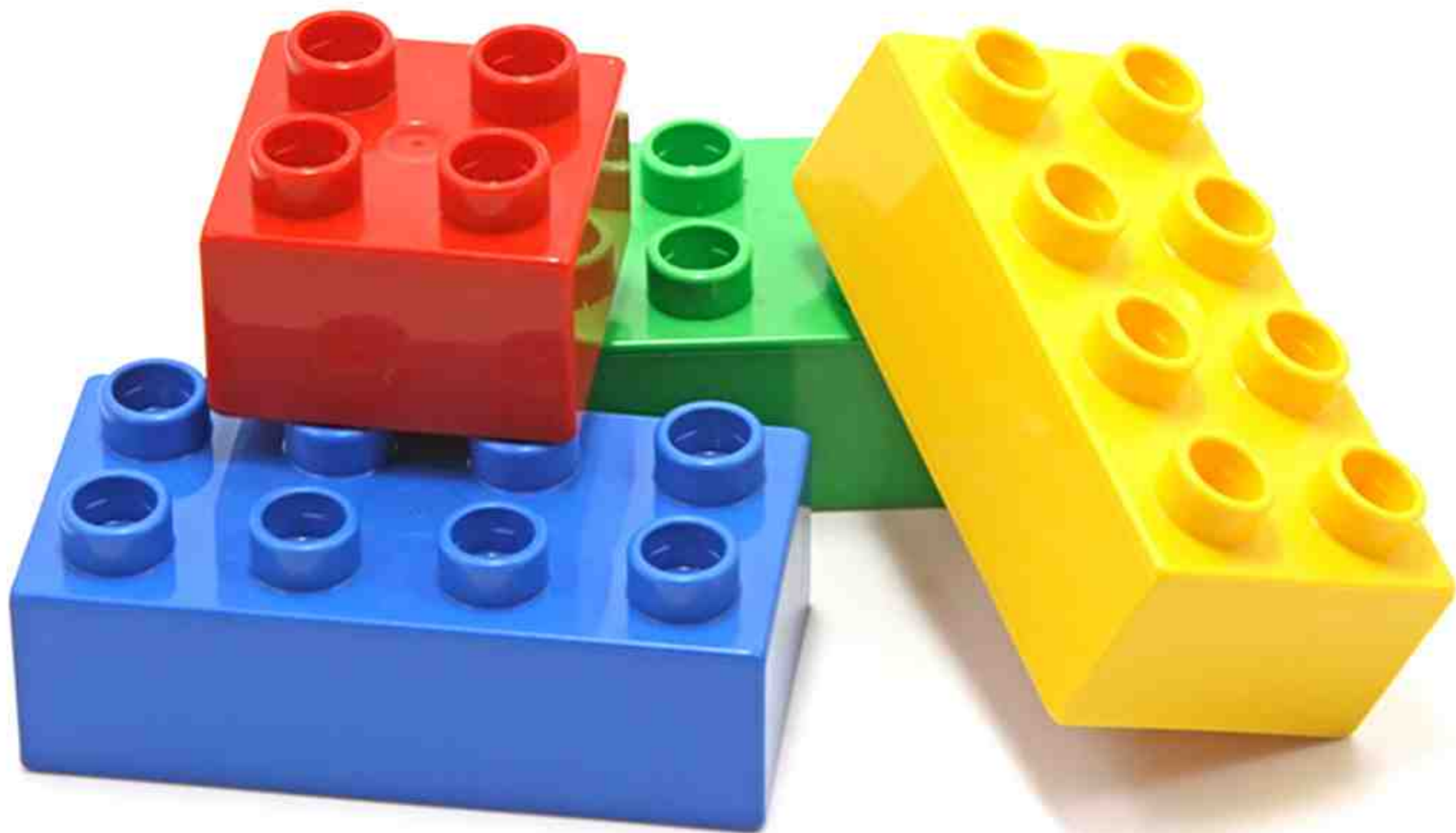



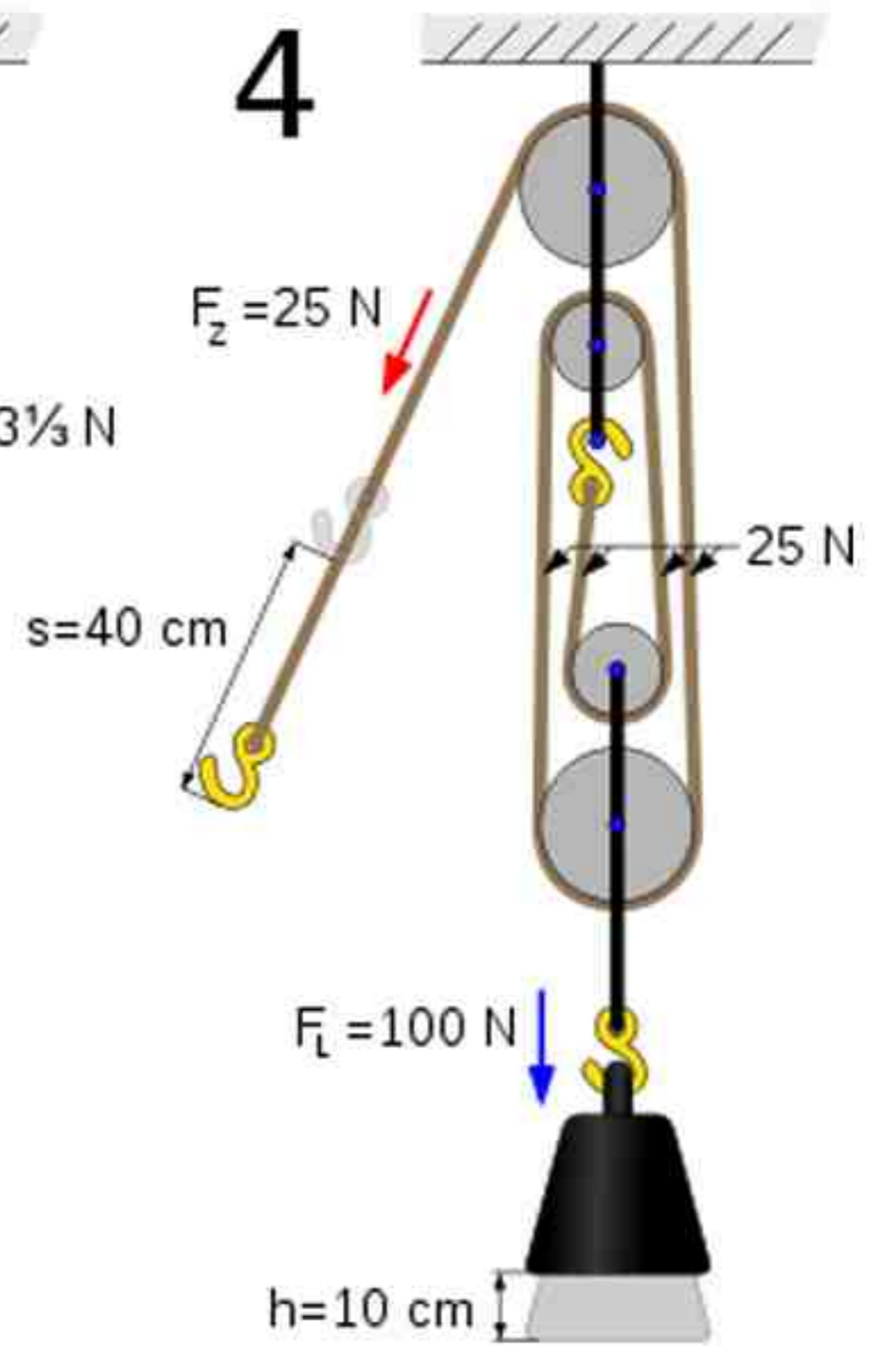
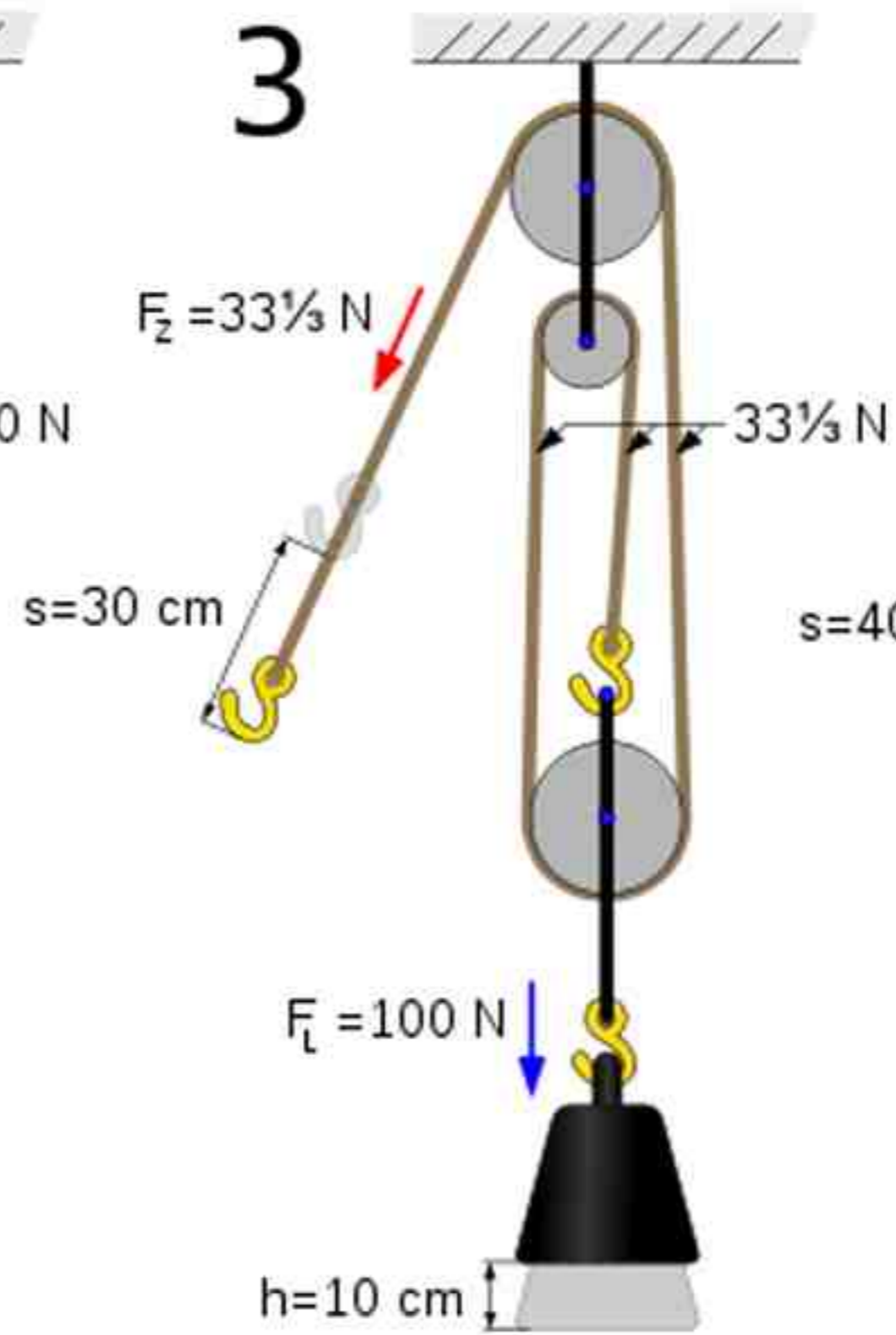
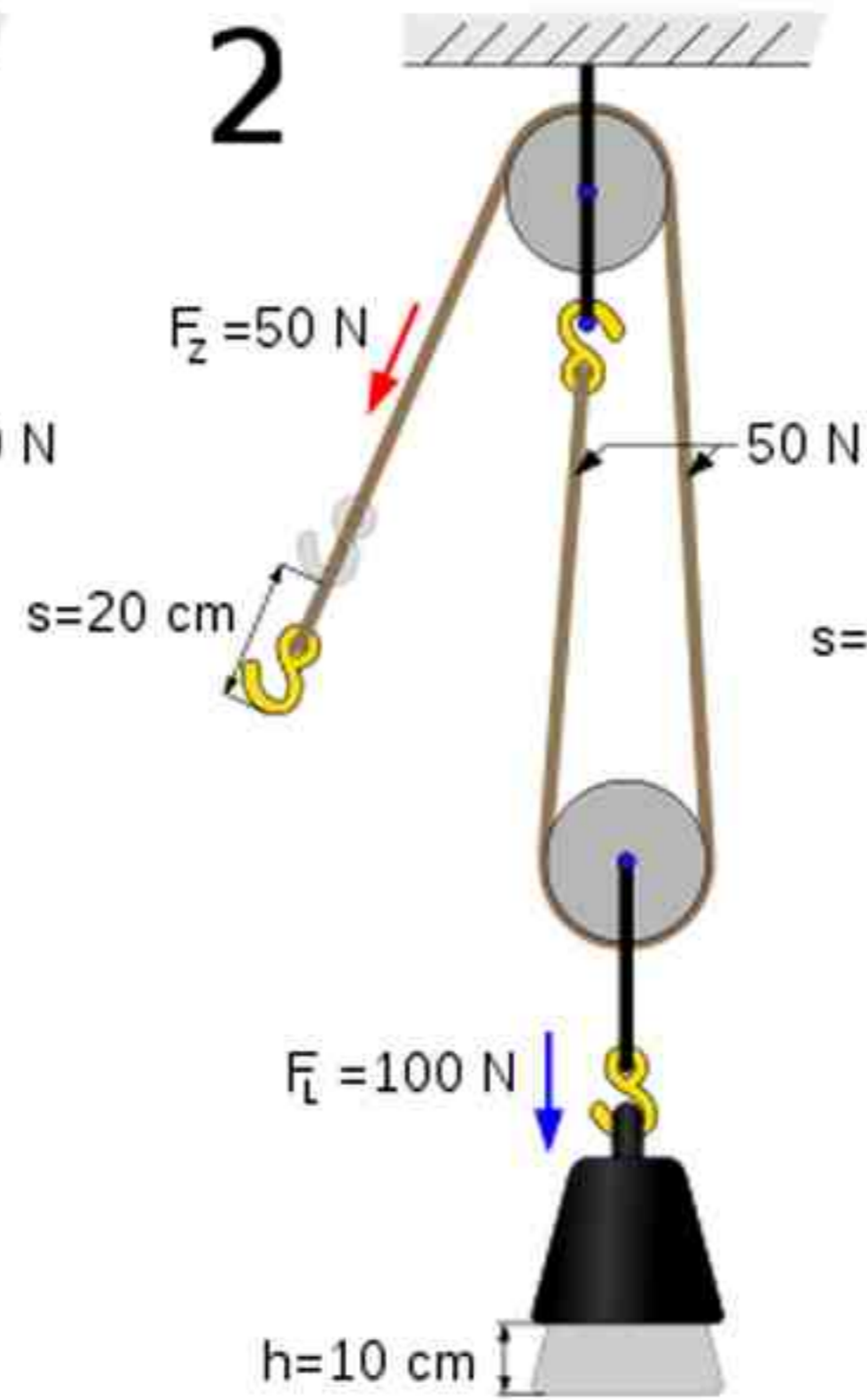
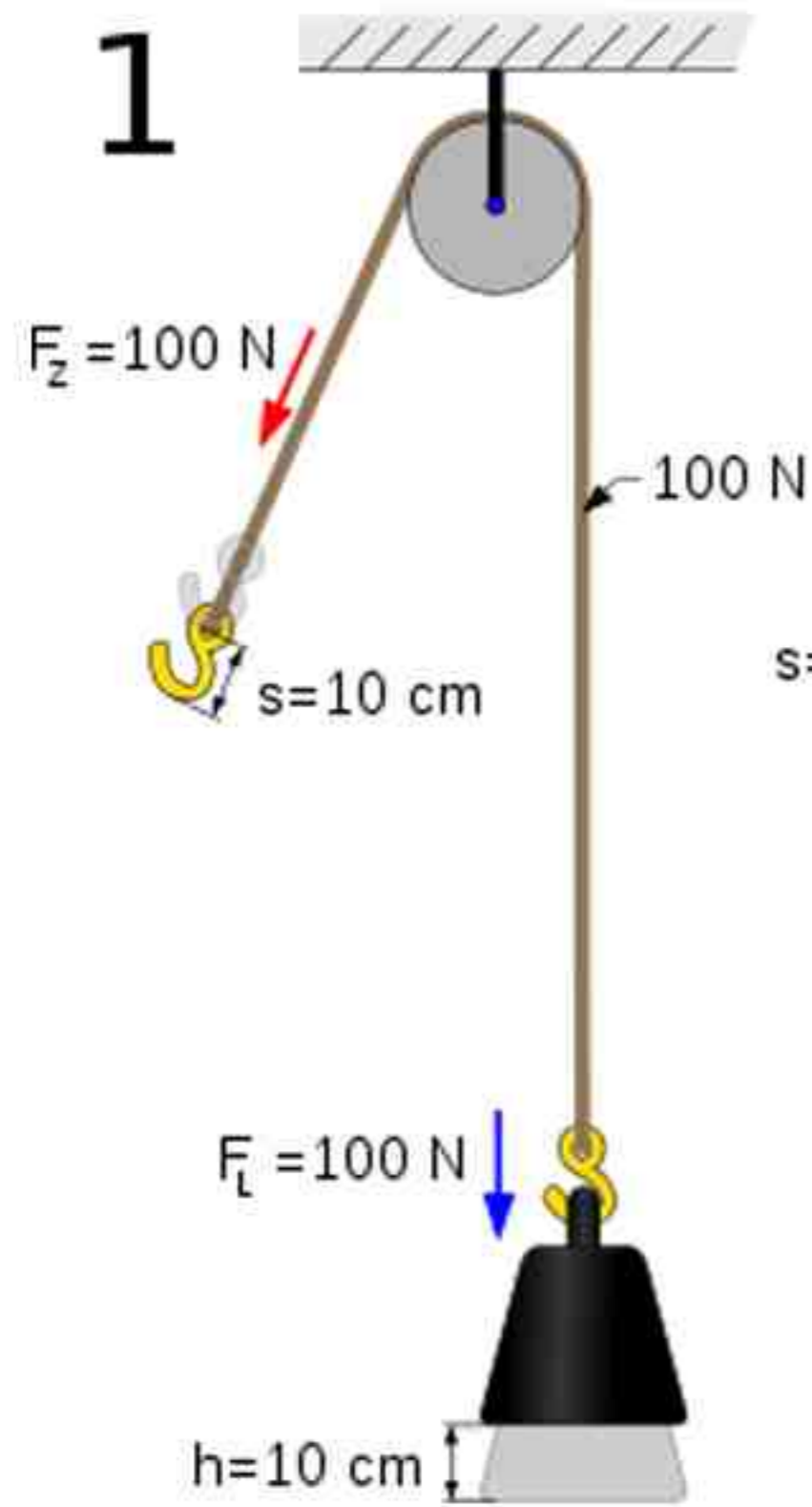





**Theirs.**

**Used at \$25,000 - \$120,000**



**Ours.**

**New at \$12,000**



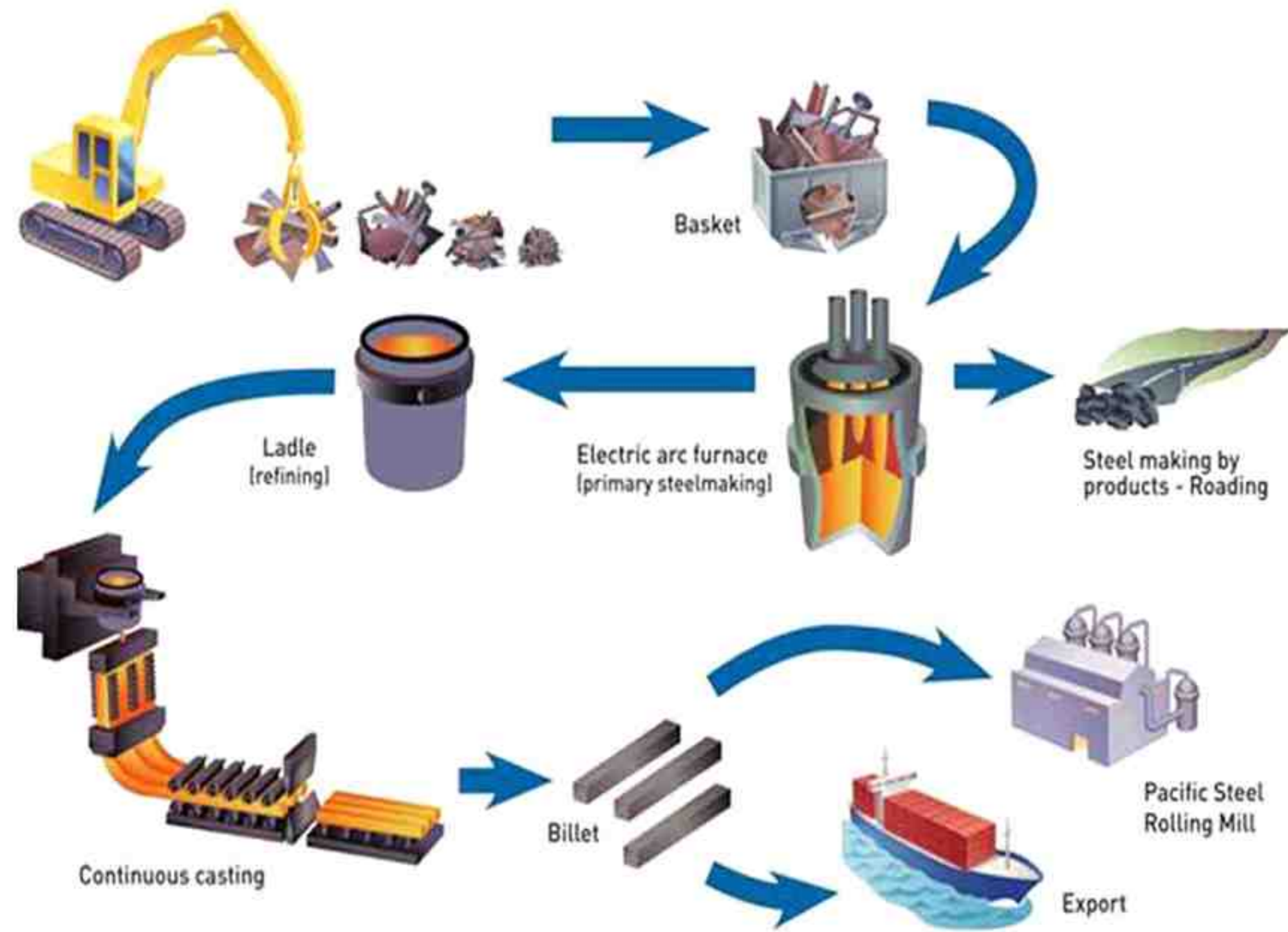

**Scrap Metal is abundant.**







QuickTime<sup>®</sup> and a  
H.264 decompressor  
are needed to see this picture.



QuickTime<sup>®</sup> and a  
H.264 decompressor  
are needed to see this picture.



QuickTime<sup>®</sup> and a  
H.264 decompressor  
are needed to see this picture.





**200 Individual Monthly Financial Donors**







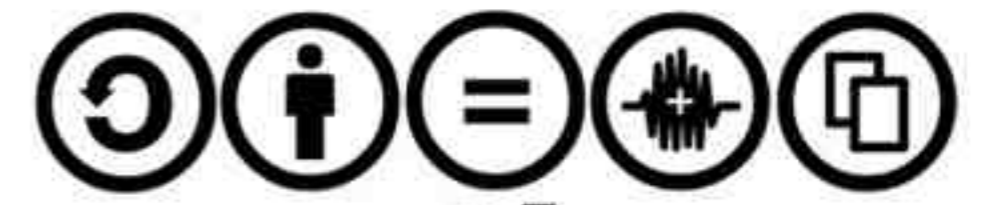

**creative  
commons**

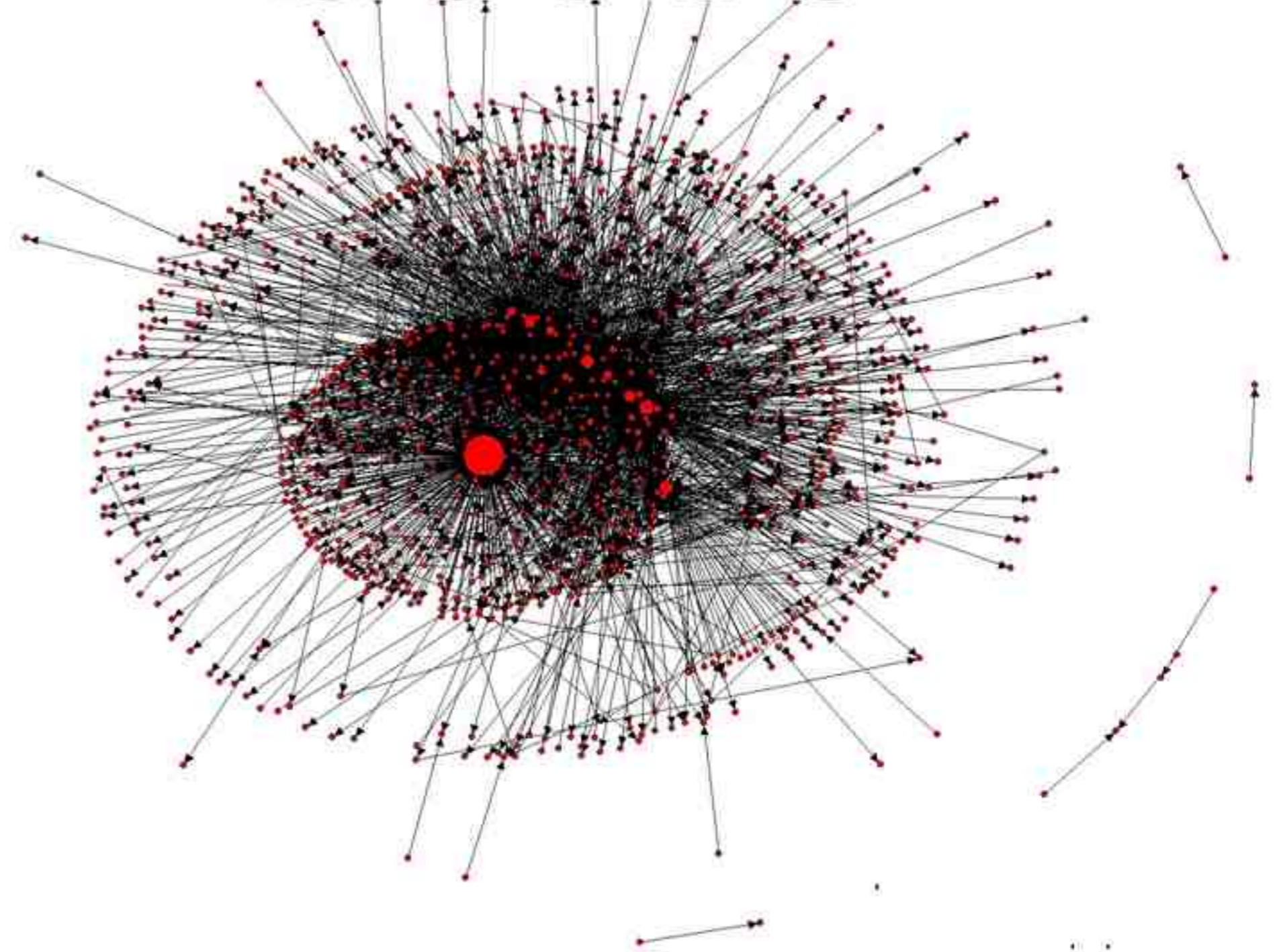
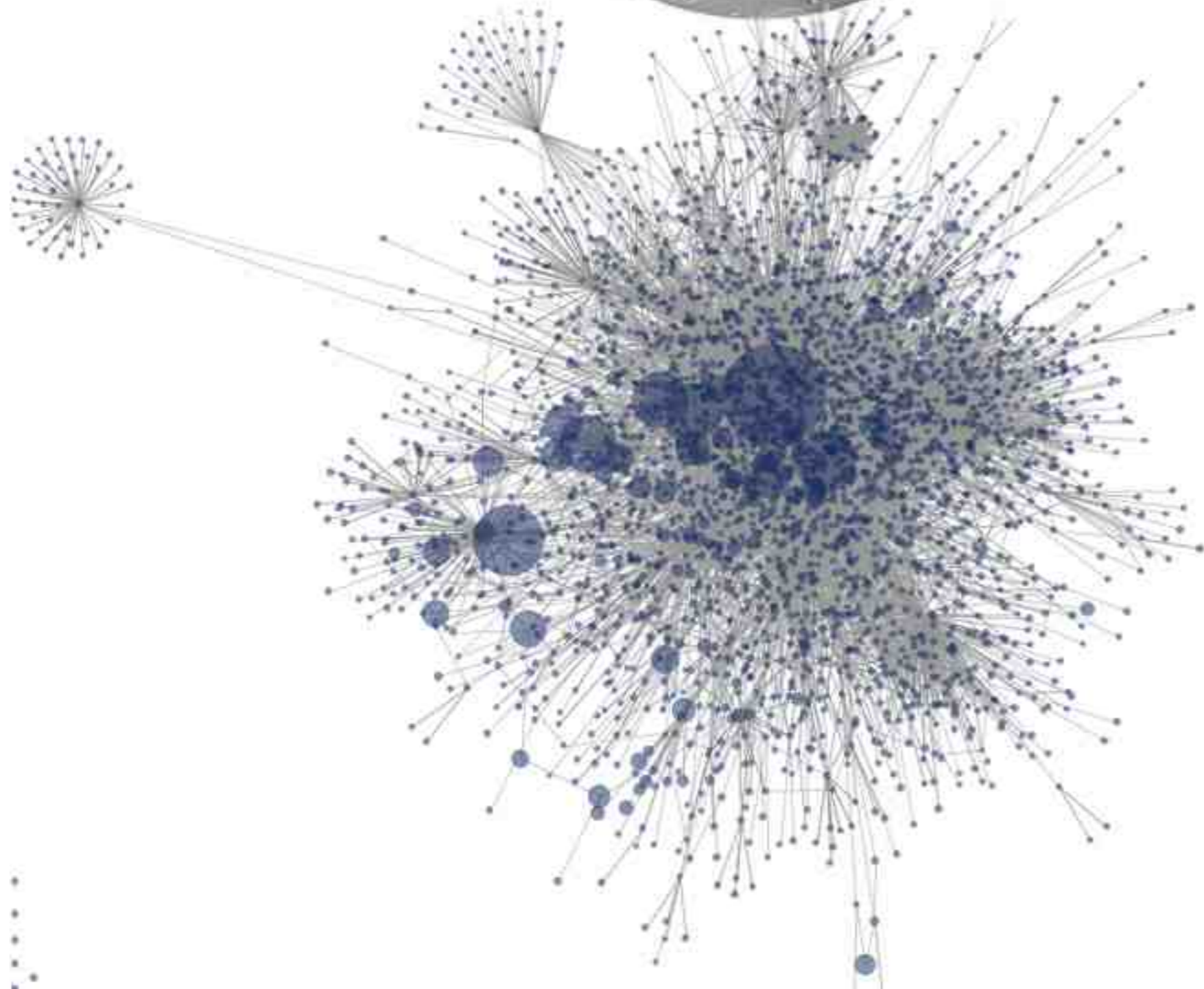





**Make:**



**Open Source Hardware**







# 2010 Global Hunger Index

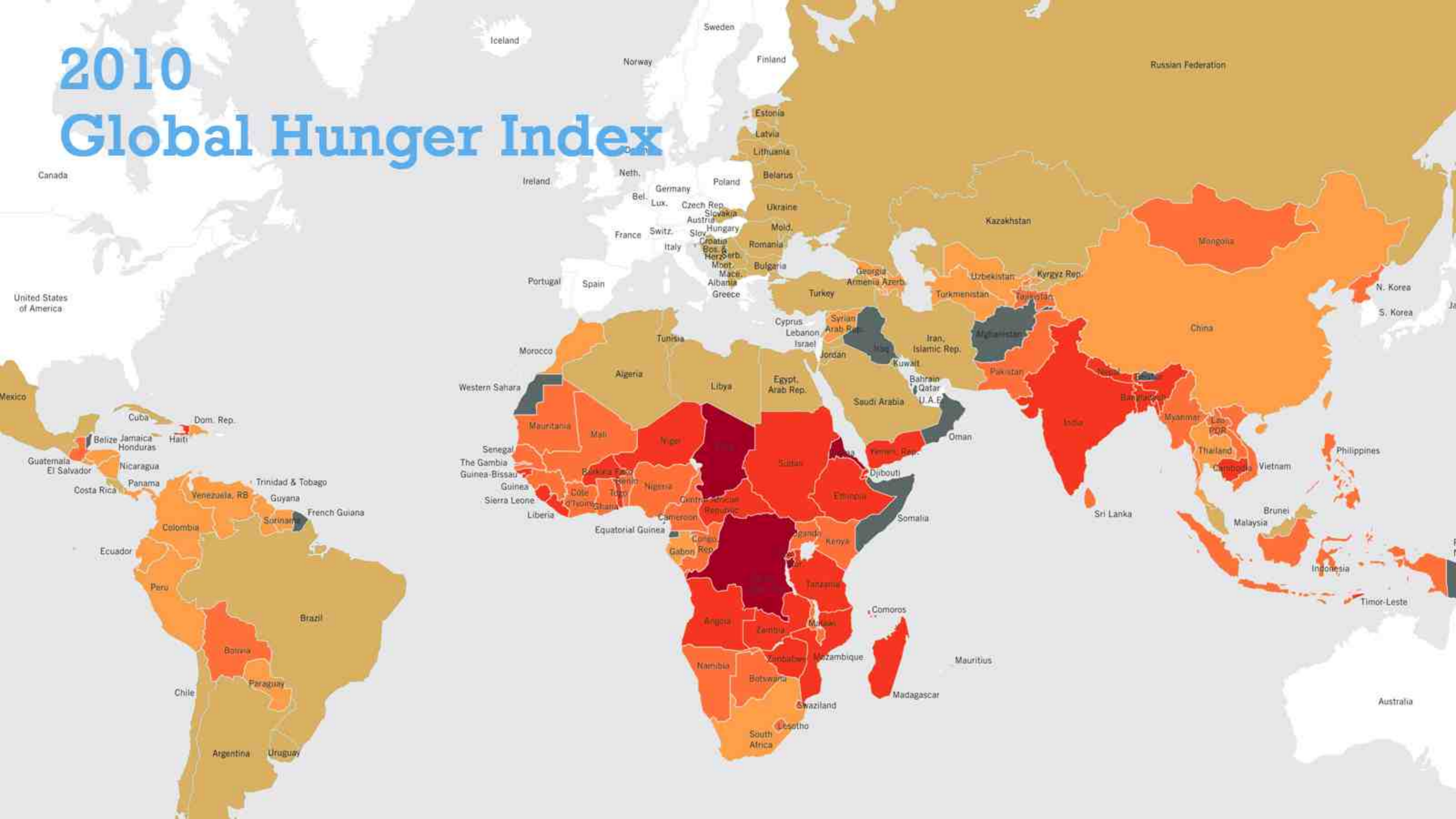









# Open Business Models













**“Nothing is as powerful as  
an idea whose time has come.”**

***- Victor Hugo***